

Expanded Metal Manufacturing Co. Ltd.

A member of Al-Jaber Group of Companies



New Industrial Area | Doha-Qatar
Building no: 455, Street: 29, Zone: 81
E-mail: gatarsales@exmetco.com
Website: www.exmetco.com
Tel: (+974) 44603826 | Fax: (+974) 44601724

WE ARE LOCATED IN 

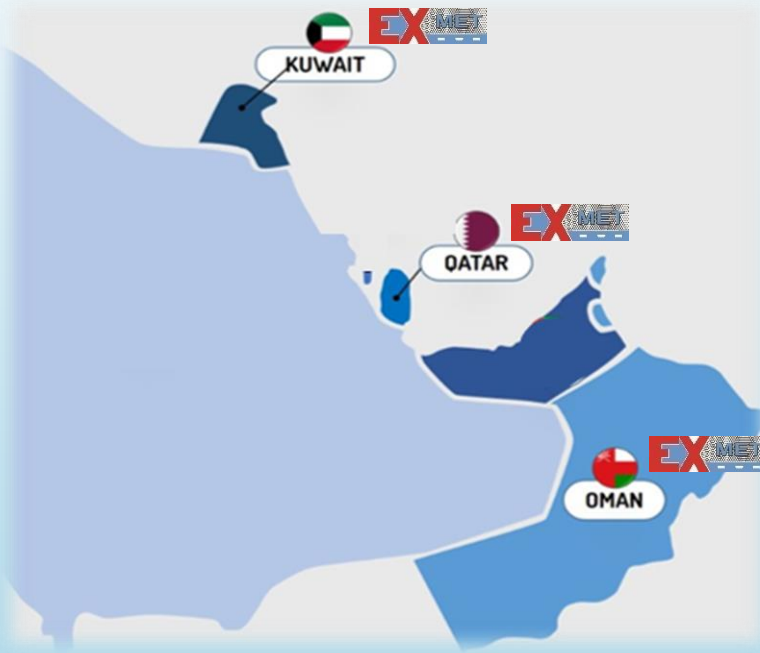

EXMET was established in the year 1992 under the ownership of Mr. Mohammed Al-Jaber and Partners

We started as the 1st manufacturer of Block & plastering accessories in Qatar and 3rd among the GCC

Our Head office and factory are located in the New Industrial Area-Qatar with an extensive space of 11,000m²

WHO WE ARE?



OUR PRODUCTS AND SERVICES

- ❑ **Block and Plastering Accessories**
- ❑ **Cable Management Systems**
- ❑ **Gypsum Accessories**
- ❑ **Cladding Fixing Systems**
- ❑ **Expansion Joint systems**
- ❑ **Shelving and Storage Solutions**

EXMET EXPERTS

Our fully equipped division to facilitate your projects by design, fabrication and installation **services.**

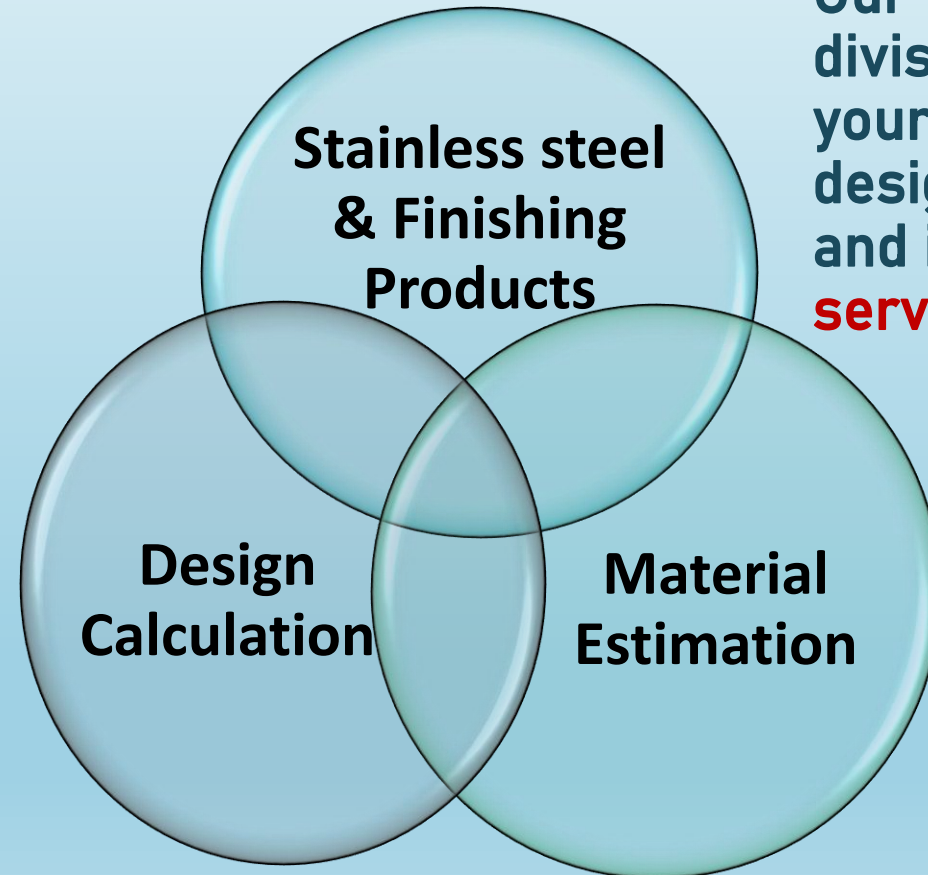

PLASTERING ACCESSORIES

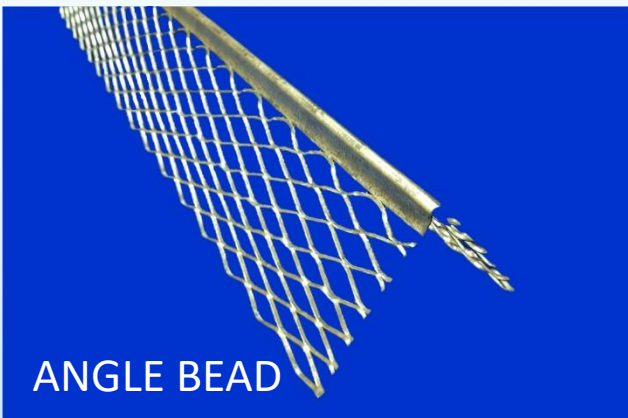

ANGLE BEAD

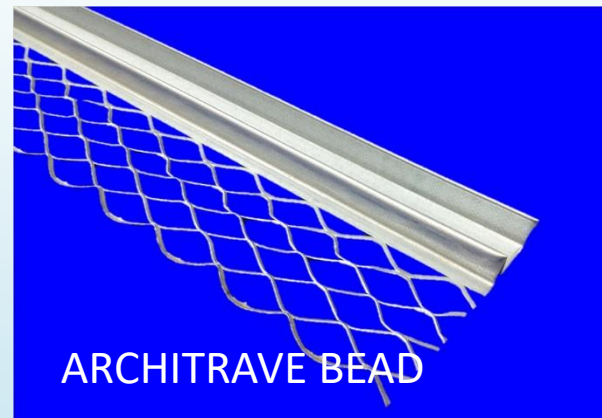

ARCHITRAVE BEAD



COIL MESH



CONTROL JOINT BEAD



FIBER GLASS MESH

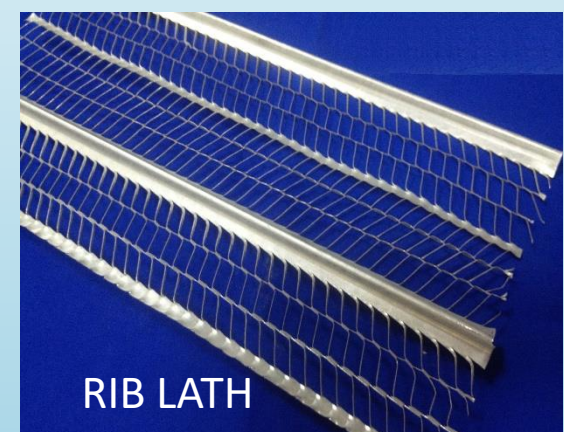

RIB LATH



PLASTER STOP BEAD

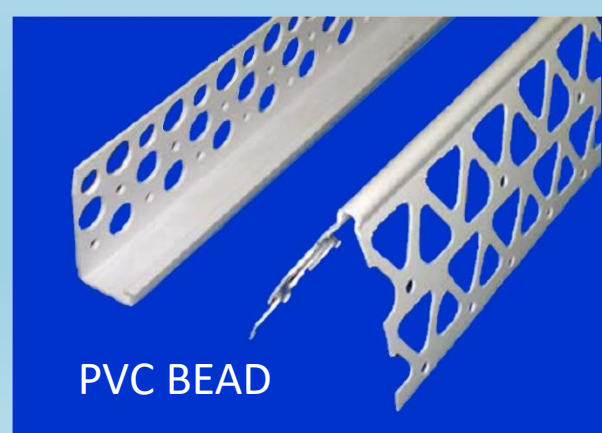

PVC BEAD



CORNER MESH

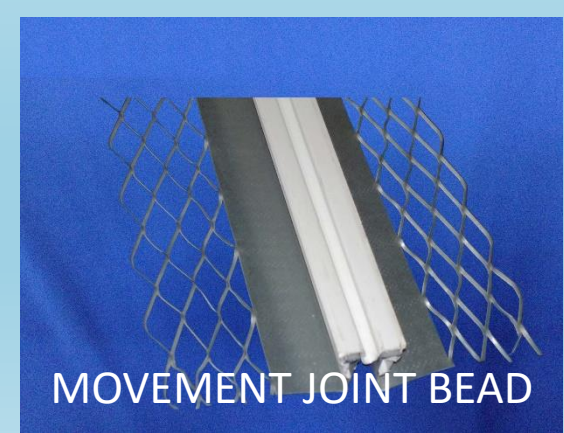

MOVEMENT JOINT BEAD

BLOCK ACCESSORIES & STEEL LINTEL

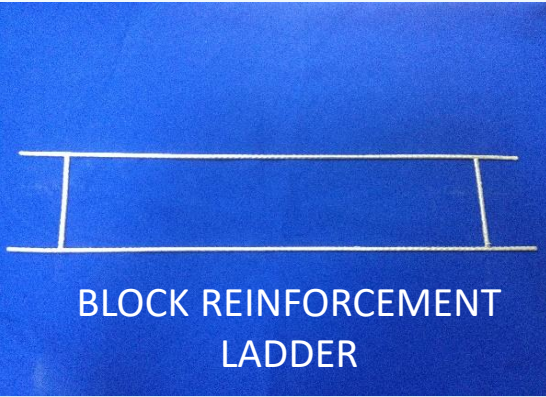

BLOCK REINFORCEMENT
LADDER

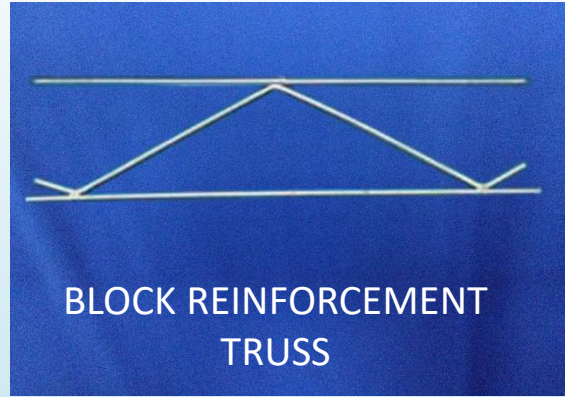

BLOCK REINFORCEMENT
TRUSS

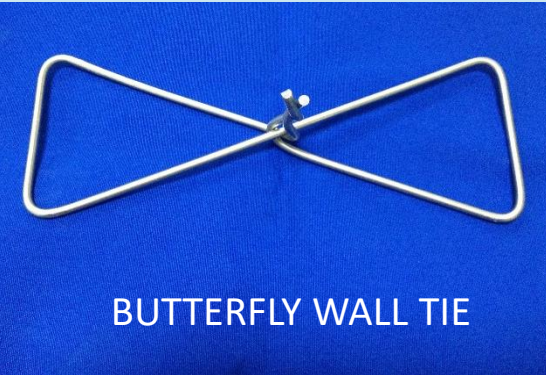

BUTTERFLY WALL TIE

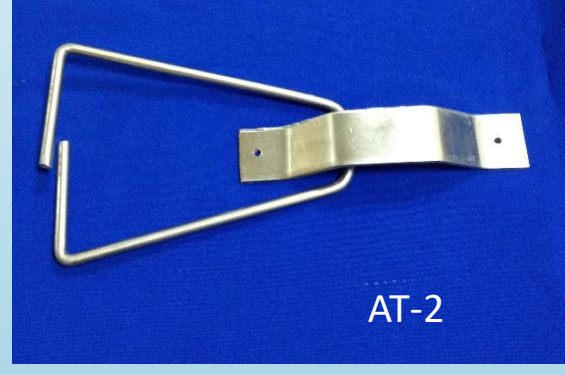

AT-2

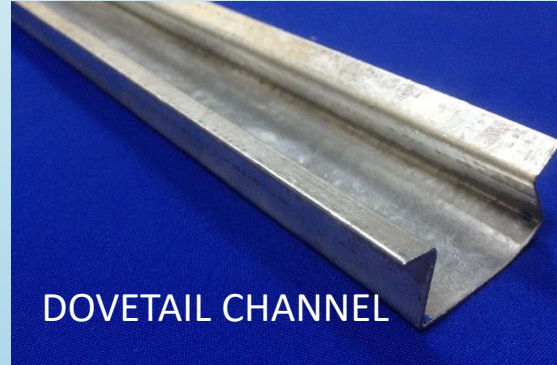

DOVETAIL CHANNEL



CORRUGATED WALL TIE



TWISTED FISHTAIL TIE



BT-3

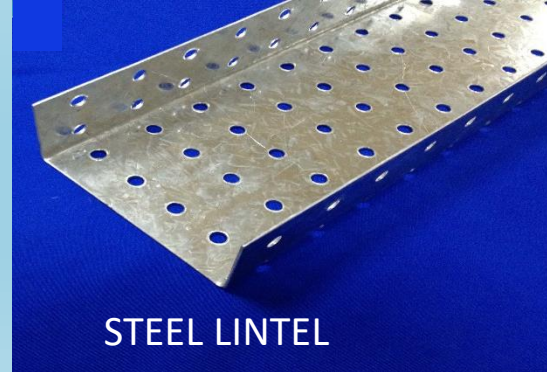

STEEL LINTEL

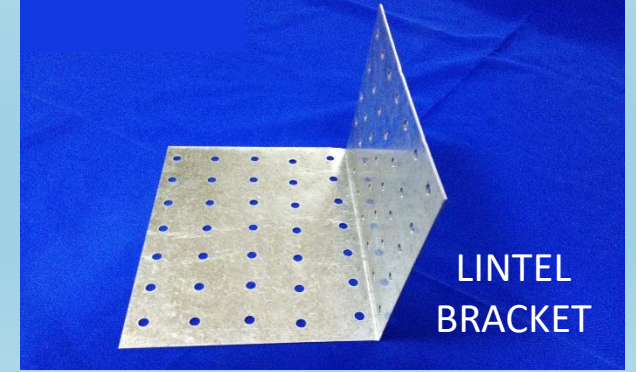

LINTEL
BRACKET

CHAIN LINK FENCE



CABLE MANAGEMENT SYSTEM

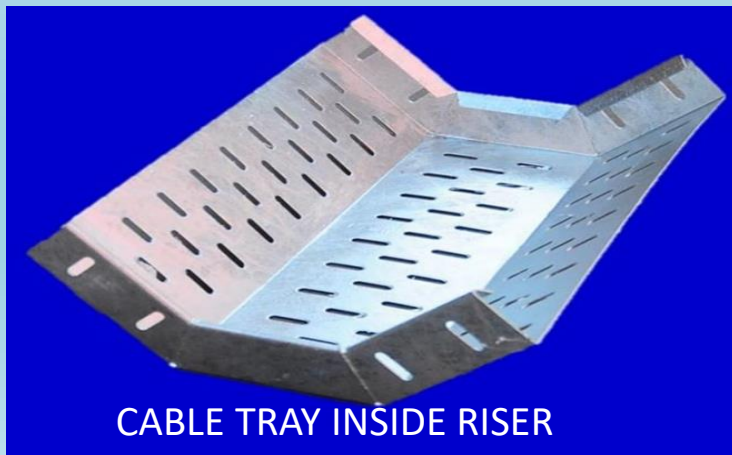
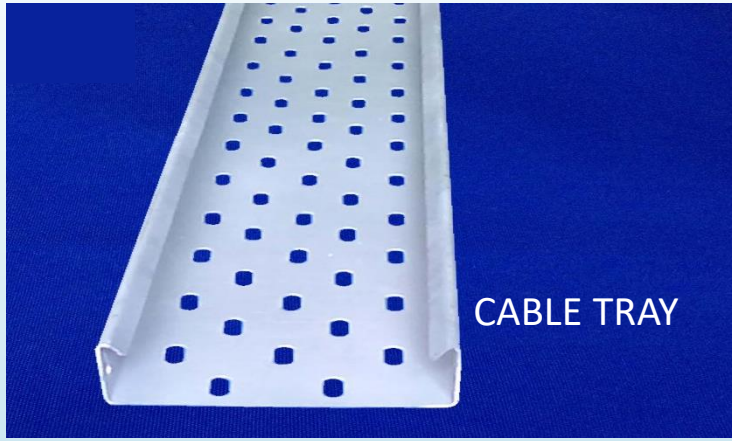

GYPSUM ACCESSORIES

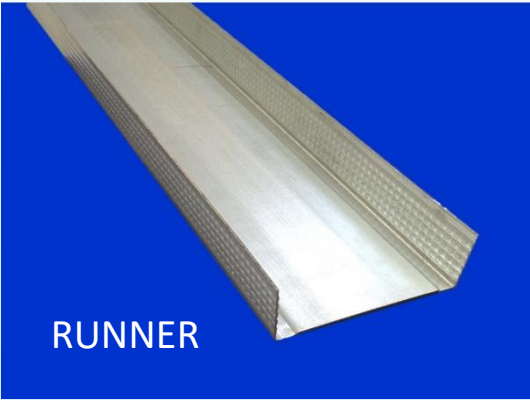

RUNNER

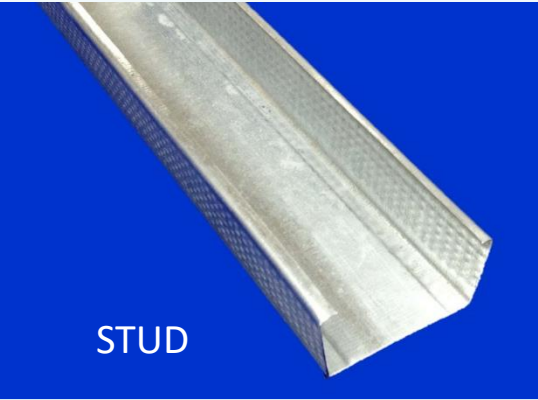

STUD



MAIN
CHANNEL



FURRING
CHANNEL



EDGING
BEAD



THIN COAT
BEAD



EXMET provides full system of mechanical cladding fixing with all needed support.

CLADDING FIXING SYSTEM

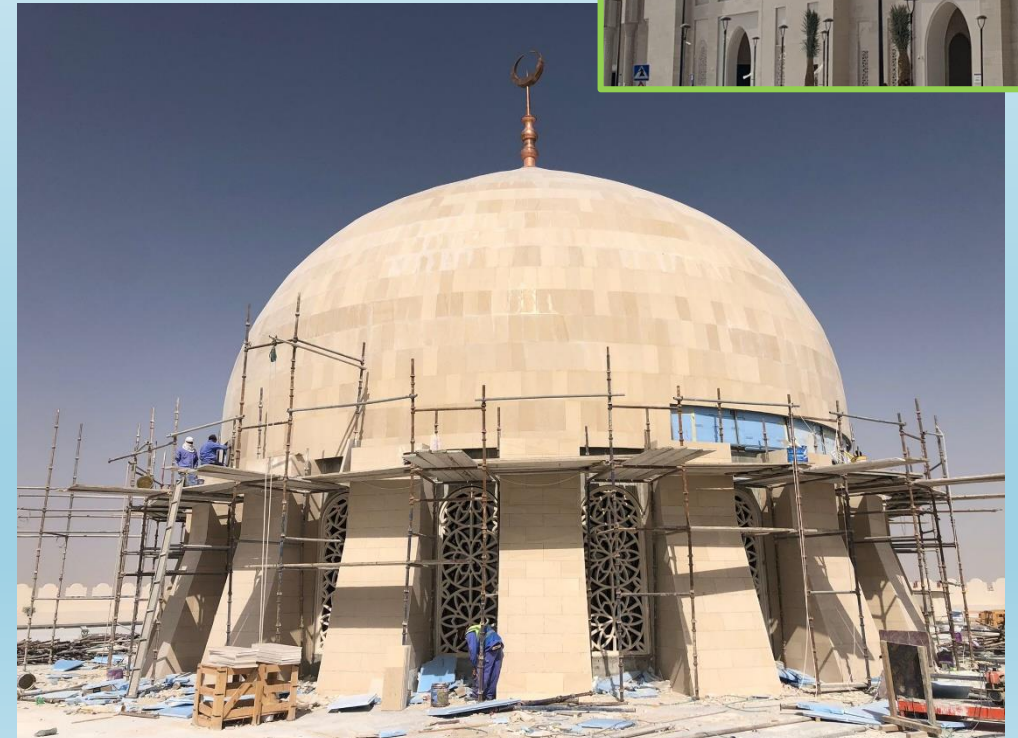

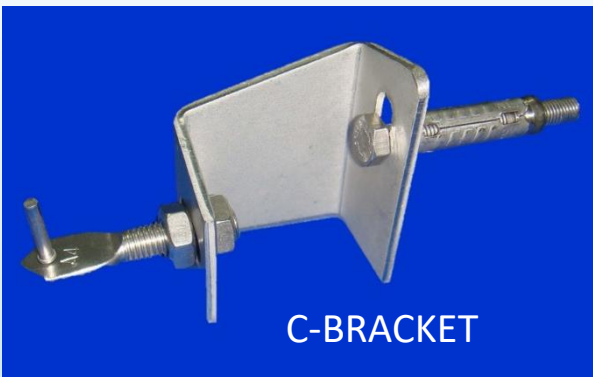

C-BRACKET



ANGLE BRACKET W/PIN

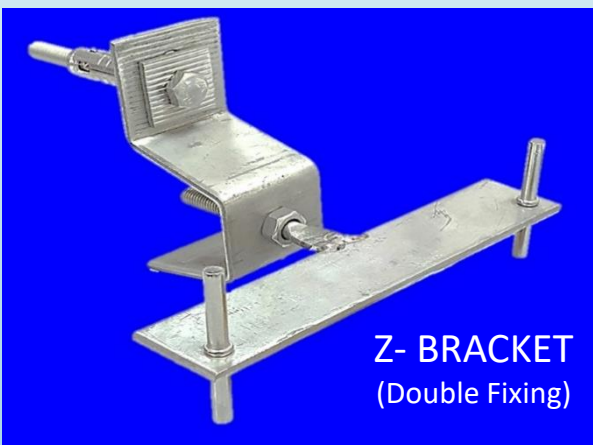

Z- BRACKET
(Double Fixing)



FISHTAIL BRACKET W/PIN

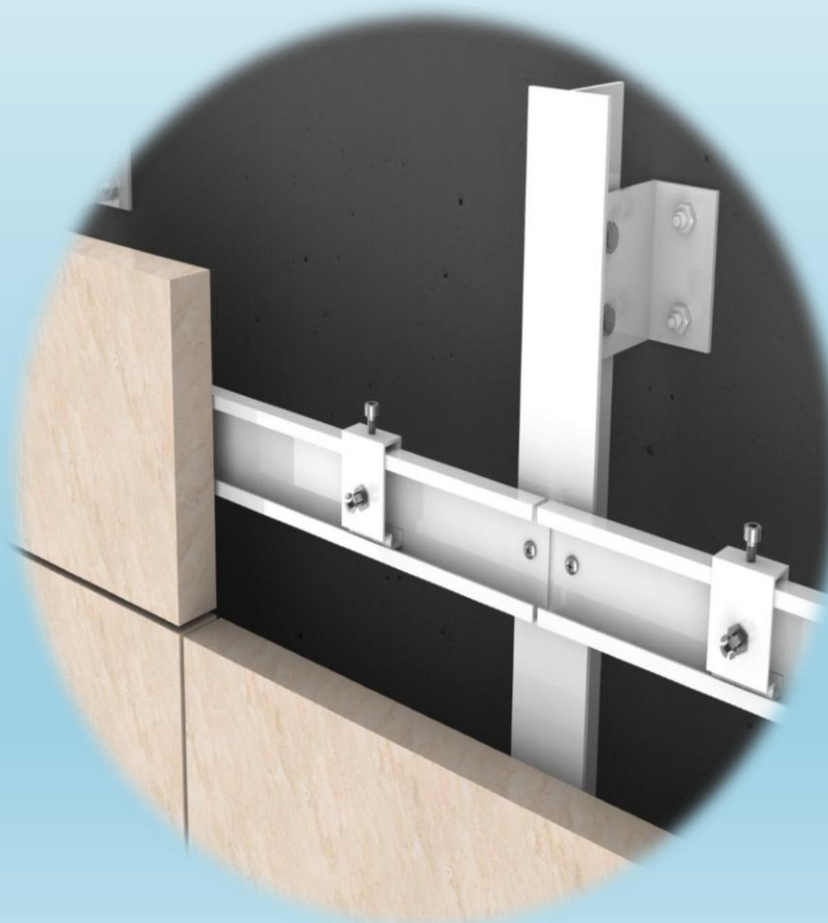

CLADDING FIXING SYSTEM



EXPANSION JOINT SYSTEM

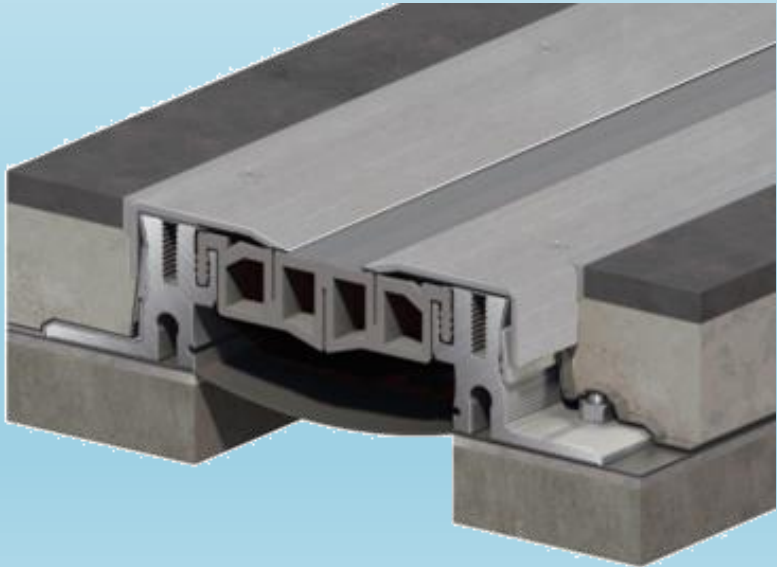
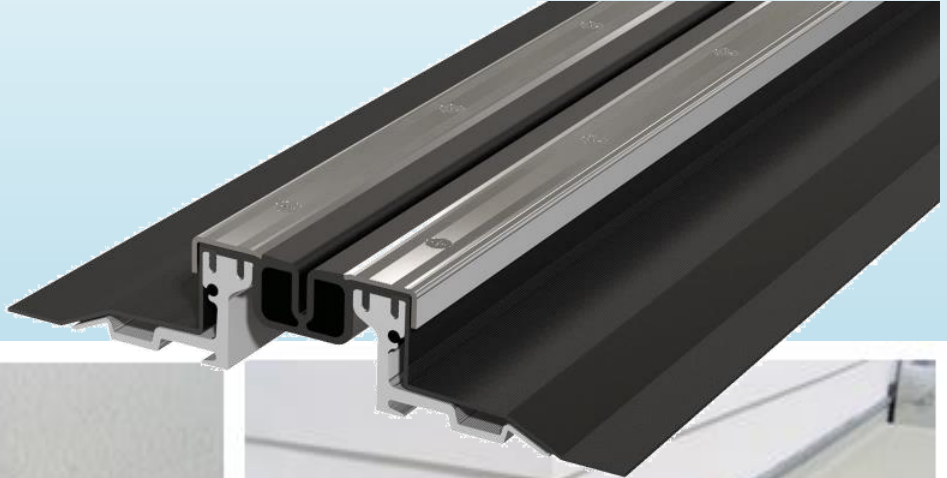
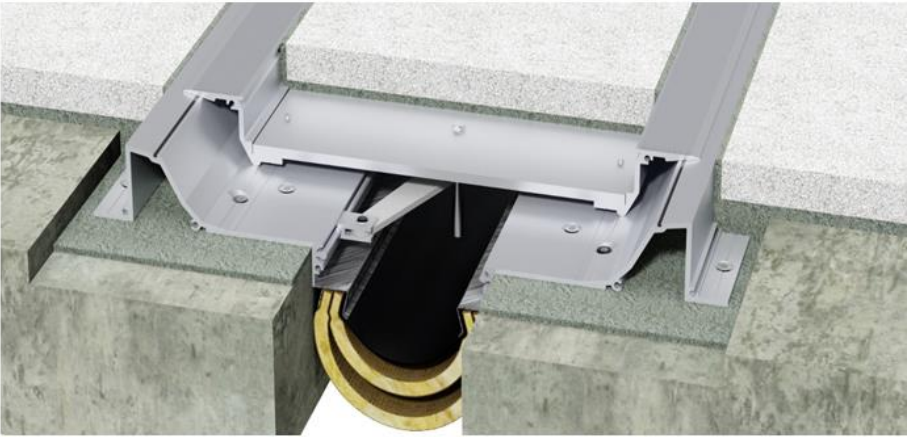

SHELVING & STORAGE SOLUTIONS



Industrial Shelving System



General Purpose Shelves



Smart Shelving System

SHELVING & STORAGE SOLUTIONS

Decorative Shelves



Supermarket Shelves



Steel Lockers

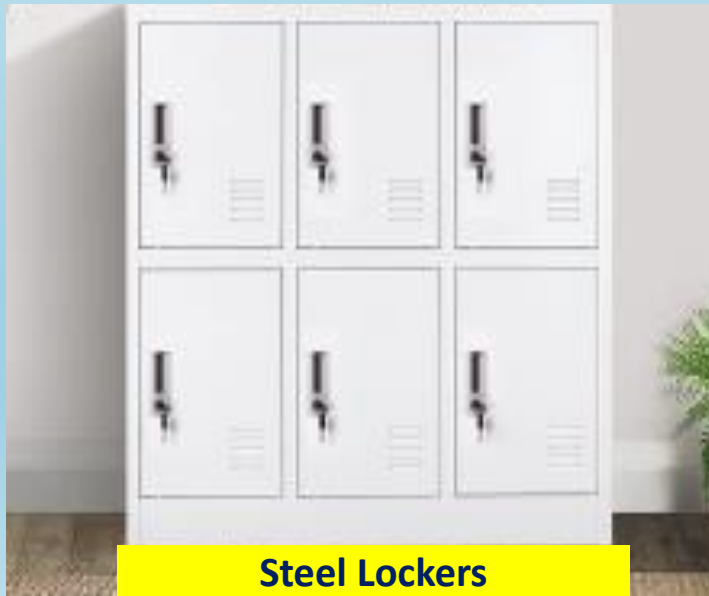

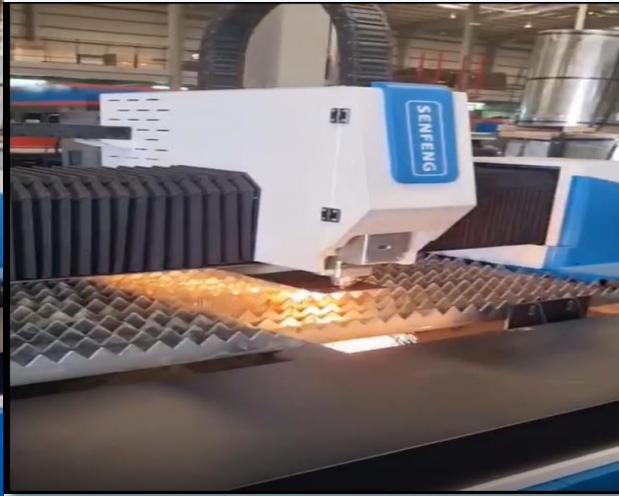

**We are equipped with
high-tech machineries
to meet the growing
needs of industries**





PROJECT REFERENCES



Doha Metro Station-Redline, Green line & Gold Line



Al Bayt Stadium



Mall of Qatar



Hamad International Airport

PROJECT REFERENCES



Msheireb Downtown



Qatar Convention Center (QNCC)



Barwa Commercial District



Ramada Hotel

INSTALLATION DIVISION

EXMET EXPERTS

EXMET EXPERTS provides full solution from design to manufacturing, supply and installation. Our facilities are equipped with the latest machines that can handle a wide range of metal fabrication works. We are always striving to expand our portfolio and meet our client's requirements, adapting to the latest developments, products and quality standards of the industry. Our products range from Non-Structural Decorative and Architectural Metals, Stainless Steel and Finishing products :

-
- | | |
|---|---|
| <input type="checkbox"/> Handrails | <input type="checkbox"/> Signage and LED Screen Framing Systems |
| <input type="checkbox"/> Specialized Hospital Items | <input type="checkbox"/> Expansion Joins and Entrance Mats |
| <input type="checkbox"/> Louvers | <input type="checkbox"/> Steel Doors |
| <input type="checkbox"/> Kitchen Cabinets | <input type="checkbox"/> Raised Floor System |
| <input type="checkbox"/> Fence | <input type="checkbox"/> Road Barriers |
| <input type="checkbox"/> Cladding | <input type="checkbox"/> Miscellaneous Steel Works |
-



EXMET EXPERTS

WORKS OF EXMET EXPERTS



QETAIFAN ISLAND: Shower Partition



AL MUSLEH VILLA: Handrails



LUSAIL PLAZA TOWER: Escalator Framing Support System



**We work hand in hand with our valued customers as a part of their team to provide best solutions for their project requirements.
Visit us at www.exmetco.com to know more**